

QUICKIE

Quickie® Z-500

SUPPLIER:
THIS MANUAL MUST BE GIVEN TO THE
RIDER OF THIS WHEELCHAIR.

RIDER:
BEFORE USING THIS WHEELCHAIR READ
THIS ENTIRE MANUAL AND SAVE FOR
FUTURE REFERENCE.

User

Instruction

Manual &

Warranty

SUNRISE LISTENS

Thank you for choosing a Quickie wheelchair. We want to hear your questions or comments about this manual, the safety and reliability of your chair, and the service you receive from your Sunrise supplier. Please feel free to write or call us at the address and telephone number below:

Sunrise Medical
Mobility Products Division
Customer Service Department
7477 East Dry Creek Parkway
Longmont, Colorado 80503
(303) 218-4500 or (800) 333-4000

Be sure to return your warranty card, and let us know if you change your address. This will allow us to keep you up to date with information about safety, new products and options to increase your use and enjoyment of this wheelchair. If you lose your warranty card, call or write and we will gladly send you a new one.

FOR ANSWERS TO YOUR QUESTIONS

Your authorized supplier knows your wheelchair best and can answer most of your questions about chair safety, use and maintenance. For future reference, fill in the following:

Supplier: _____

Address: _____

Telephone: _____

Serial #: _____ Date/Purchased: _____

I. INTRODUCTION	3
II. TABLE OF CONTENTS	4
III. YOUR CHAIR AND ITS PARTS	6
IV. NOTICE - READ BEFORE USE	8
V. EMI (ELECTROMAGNETIC INTERFERENCE)	9
A. What Is EMI?.....	9
B. What Effect Can EMI Have?.....	9
C. Sources Of EMI.....	9
D. Distance From The Source.....	10
E. Immunity Level.....	10
F. Report All Suspected EMI Incident.....	11
VI. GENERAL WARNINGS	12
A. Notice To Rider.....	12
B. Notice To Attendants.....	12
C. Weight Limit.....	13
D. Controller Settings.....	13
E. EMI.....	13
F. Safety Check-List.....	13
G. Changes & Adjustments.....	13
H. When Seated In A Parked Wheelchair.....	14
I. Environmental Conditions.....	14
J. Terrain.....	15
K. Street Use.....	15
L. Motor Vehicle Safety.....	15
M. Center Of Balance.....	15
N. Transfers.....	16
O. Reaching Or Leaning.....	17
P. Dressing Or Changing Clothes.....	17
Q. Obstacles.....	18
R. Driving In Reverse.....	18
S. Ramps, Slopes & Sidehills.....	18
T. To Reduce The Risk Of A Fall, Tip-Over Or Loss Of Control.....	19
U. Ramps At Home & At Work.....	20
V. Wheelchair Lifts.....	20
W. Curbs & Single Steps.....	21
X. Stairs.....	21
Y. Escalators.....	21
VII. WARNINGS: COMPONENTS & OPTIONS	22
A. Anti-Tip Levers.....	22
B. Armrests.....	22
C. Batteries.....	22
D. Cushions & Sling Seats.....	22
E. Fasteners.....	22
F. Footrests.....	23
G. Motor Locks.....	23
H. On/Off Switch.....	23
I. Pneumatic Tires.....	23
J. Positioning Belts (Optional).....	24
K. Push Handles.....	24
L. Rear Wheel Locks (Optional).....	24

M. Seating Systems.....	25
N. Upholstery Fabric.....	25
VIII. TIPS FOR ATTENDANTS	26
A. To Climb A Curb Or Single Step.....	26
B. To Descend A Curb Or Single Step.....	26
IX. SET-UP, ADJUSTMENT & USE	27
A. Swing-Away Footrest.....	28
B. 90° Footboard.....	29
C. Articulating Legrest (Optional).....	29
D. Elevating Legrest (Optional).....	30
E. Remote Joystick Installation (Optional).....	30
F. To Adjust the Height of the Remote Joystick.....	30
G. Remote Joystick Swing-Away Retractable Mount (Optional).....	31
H. Solid Back And Seat Insert.....	31
I. Wheel Locks.....	31
J. Height-Adjustable Armrest (Optional).....	32
K. Adjustable Locking Flip-up Armrest (Optional).....	32
L. Seat Depth.....	33
M. Tilt-In-Space Mechanism.....	33
N. Nontilt.....	33
O. Strut Tubes.....	34
P. Check-Out.....	34
X. OPERATING GUIDE	35
A. Performance Control Settings.....	35
B. QTRONIX Programming Pad (Optional).....	35
C. Thermal Roll Back.....	36
D. Circuit Breakers.....	36
E. Joystick Assembly.....	36
F. Motor Locks.....	38
XI. BATTERIES	39
A. Introduction.....	39
B. Battery Charger.....	39
C. Acid Burns.....	40
D. Connecting Batteries in Battery Box(es).....	41
E. Charging Batteries.....	42
F. Disposing of Batteries.....	43
XII. MAINTENANCE	44
A. Notes.....	44
B. Cleaning.....	44
C. Storage Tips.....	44
D. Battery Maintenance.....	44
E. Pneumatic Tires.....	45
F. To Repair or Replace a Tire.....	46
G. Motor Brushes.....	47
H. Ordering Parts.....	47
I. Maintenance Chart.....	47
XIII. WIRING DIAGRAM	48
XIV. SUNRISE LIMITED WARRANTY	49

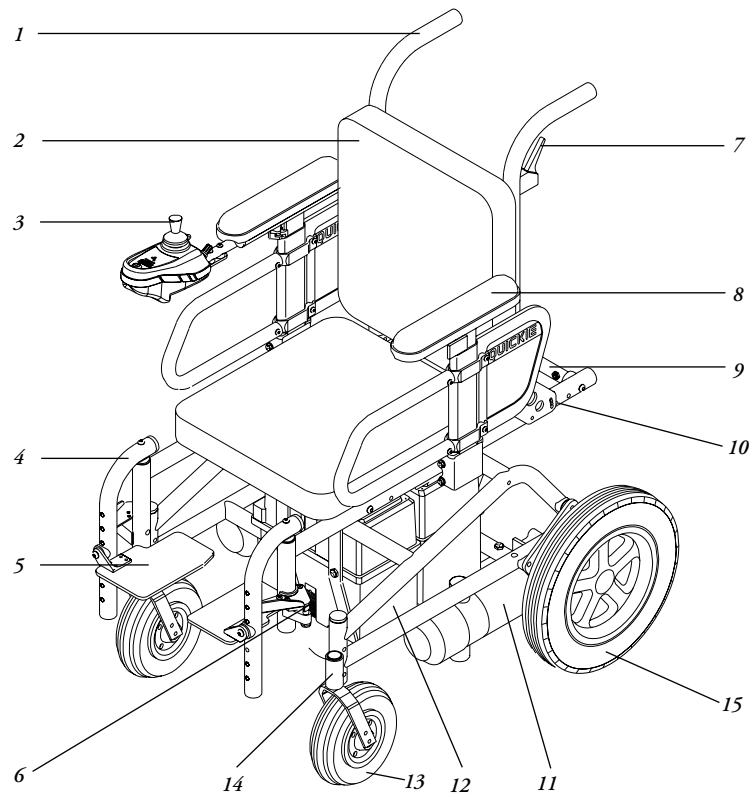

Quickie Z-500

- | | |
|--|--------------------------|
| 1. Stroller handle | 8. Armrest |
| 2. Solid back | 9. Strut tube |
| 3. Joystick | 10. Backrest pivot plate |
| 4. Swing-away hanger | 11. Motors |
| 5. Footplate | 12. Battery boxes |
| 6. Swing-away release latch | 13. Caster tire |
| 7. Tilt-in-space mechanism release lever | 14. Caster housing |
| | 15. 12" Drive wheels |

Weight

65 lbs. with swing-away footrests and armrests, without batteries

Drive Wheels

12" Mag

Tire types: Standard - pneumatic,
Option - airless insert

Joystick

Standard - remote (right-hand or left-hand mount)

Option - Swing-away retractable, heavy-duty remote or heavy-duty, swing-away retractable

Batteries

(2 deep cycle batteries required to operate chair)

Option - group 22 NF lead acid, 22 NF gel, U1 - lead acid, U1 gel

Battery Charger

Standard - dual mode (Lester)

Color

Standard - blue, black, red, midnight purple, pearl pink, forest green, burgundy, yellow, blue green, black opal, toxic green, blue velvet, candy teal, candy purple.

Seat/Frame Dimensions

Seat width: 12" - 14"

Option - 15" - 16"

Seat depth: 10" - 15"

Back/Seat Options

Standard - Stroller handles,
Option - removable extensions

Backheight: Standard - 11"/12",
13"/14", 15"/16"

Upholstery color Options:

Standard - black, Option - blue, red,
hot pink

Footrest

Standard - Swing-away with composite footplates and heel loops

Option - articulating legrests, elevating legrests, angle-adjustable footplate, extended, platform flip-up, toe loops, footrest ext. tubes

Casters

Standard - 8" pneumatic

Option - 8" airless insert

Armrest

Standard - height-adjustable with Standard or full length pad

Option - adjustable locking flip-up

Wheel Locks

Standard - push-to-lock

Option - pull-to-lock, 6" or 9" extension handles

All features may not be available with some chair setups or in conjunction with another chair feature. Please consult your supplier for more information. Your authorized supplier can also provide you with more information on accessories and clothing.

A. CHOOSE THE RIGHT CHAIR & SAFETY OPTIONS

Sunrise provides a choice of many power wheelchair styles, sizes and adjustments to meet the needs of the rider. However, final selection of a wheelchair rests solely with you and your health care professional. Choosing the best chair for you depends on such things as:

1. Your size, disability, strength, balance and coordination.
2. Your intended use and your level of activity.
3. The types of hazards you must overcome in daily use (in areas where you are likely to use your chair).
4. The need for options for your safety and comfort (such as positioning belts or special seat systems).

B. ADJUST CHAIR TO YOUR ABILITY

You need to work with your doctor, nurse or therapist, and your supplier, to fit this chair and adjust the controller settings for your level of function and ability.

C. REVIEW THIS MANUAL OFTEN

Before using this chair you, and each person who may assist you, should read this entire Manual and make sure to follow all instructions. Review the warnings often, until they are second nature to you.

D. WARNINGS

The word “WARNING” refers to a hazard or unsafe practice that may cause severe injury or death to you or to other persons. The “Warnings” are in four main sections, as follows:

1. V — EMI

Here you will learn about electromagnetic interference and how it can affect your chair.

2. VI — GENERAL WARNINGS

Here you will find a safety checklist and a summary of risks you need to be aware of before you ride this chair.

3. VII — WARNINGS — COMPONENTS & OPTIONS

Here you will learn about your chair. Consult your supplier and your health care professional to help you choose the best set-up and options for your safety.

4. XI — BATTERIES

Here you will learn about battery and charger safety, and how to avoid injury.

NOTE– Where they apply, you will also find “Warnings” in other sections of this Manual.

⚠ WARNING**Heed all warnings to reduce the risk of unintended brake release or chair movement:**

1. Beware of the danger from hand-held transceivers. Never turn on or use a hand-held transceiver while power to your chair is on. Use extra care if you believe that such a device may be in use near your chair.
2. Be aware of nearby radio or TV stations, and avoid coming close to them.
3. If unintended movement occurs, turn your chair off as soon as it is safe to do so.

A. WHAT IS EMI?**⚠ WARNING**

1. EMI means: electromagnetic (EM) interference (I). EMI comes from radio wave sources such as radio transmitters and transceivers. (A “transceiver” is a device that both sends and receives radio wave signals).
2. There are a number of sources of intense EMI in your daily environment. Some of these are obvious and easy to avoid. Others are not, and you may not be able to avoid them.
3. Powered wheelchairs may be susceptible to electromagnetic interference (EMI) emitted from sources such as radio stations, TV stations, amateur radio (HAM) transmitters, two way radios, and cellular phones.
4. EMI can also be produced by conducted sources or electro-static discharge (ESD).

B. WHAT EFFECT CAN EMI HAVE?**⚠ WARNING**

1. EMI can cause your chair, without warning, to:
 - Release its brakes
 - Move by itself
 - Move in unintended directions
 If any of these occurs, it could result in severe injury to you or others.
2. EMI can damage the control system of your chair. This could create a safety hazard, and lead to costly repairs.

C. SOURCES OF EMI**⚠ WARNING**

The sources of EMI fall into three broad types:

1. Hand-Held Transceivers:

The antenna is usually mounted directly on the unit. These include:

 - Citizens band (CB) radios
 - “Walkie-talkies”
 - Security, fire and police radios
 - Cellular phones
 - Lap-top computers with phone or fax
 - Other personal communication devices

NOTE– These devices can transmit signals while they are on, even if not in use.

2. Medium-Range Mobile Transceivers:

These include two-way radios used in police cars, fire trucks, ambulances and taxi cabs. The antenna is usually mounted on the outside of the vehicle.

3. Long-Range Transceivers:

These include commercial radio and TV broadcast antenna towers and amateur (HAM) radios.

NOTE– The following are not likely to cause EMI problems: Lap-top computers (without phone or fax), Cordless phones, TV sets or AM/FM radios, CD or tape players.

D. DISTANCE FROM THE SOURCE**⚠ WARNING**

EM energy rapidly becomes more intense as you get closer to the source.

For this reason, EMI from hand-held devices is of special concern.

(See C.1 pg. 9) A person using one of these devices can bring high levels of EM energy very close to your chair without you knowing it.

E. IMMUNITY LEVEL**⚠ WARNING**

1. The level of EM is measured in volts per meter (V/m). Every power wheelchair can resist EMI up to a certain level. This is called its "immunity level".
2. The higher the immunity level, the less the risk of EMI. It is believed that a 20 V/m immunity level will protect the power wheelchair user from the more common sources of radio waves.
3. The configuration tested and found to be immune to at least 20 V/m is: Quickie Z-500 power wheelchair with a right-hand mounted QTRONIX remote joystick system, single-post height-adjustable armrests, 90° hangers, 13" seat width, 15" seat depth and 22NF gel cell batteries.
4. The following specialty input devices have an unknown effect on the immunity level because they have not been tested with the Z-500:
 - Breath Control
 - Tri-Switch Head Array
 - Heavy Duty Switched Joystick
 - Treadle Switch
 - Ribbon Switch
 - Proximity Head Array
 - Zero Touch Switch
 - 4-Zero Touch Switch
 - 5-Zero Touch Switch
 - Disc Switch
 - Proportional Head Control
 - Proportional Mini-Joystick/Chin Control

- Buddy Button
- Micro Light
- Star Board
- Wafer Board
- Penta Switch
- Plate Switch
- Soft Switch
- Grasp Switch
- Wobble Switch

⚠ WARNING

Individuals with physical limitations requiring the use of a specialty control input device known not to be immune to 20V/m, or not known, should exercise extra care around known sources of EMI.

⚠ WARNING

There is no way to know the effect on EMI if you add accessories or modify this chair. Any change to your chair may increase the risk of EMI. Parts from other suppliers have unknown EMI properties.

F. REPORT ALL SUSPECTED EMI INCIDENTS**⚠ WARNING**

You should promptly report any unintended movement or brake release. Be sure to indicate whether there was a radio wave source near your chair at the time. Contact: Customer Service Department at (800) 333-4000.

⚠ WARNING

Heed all warnings in this section. If you fail to do so a fall, tip-over or loss of control may occur and cause severe injury to you or others.

A. NOTICE TO RIDER**⚠ WARNING**

1. Before using this chair, you should be trained in its safe use by your health care professional.
2. Every wheelchair is different. Take the time to learn the feel of this chair before you begin riding.
3. Be aware that you must develop your own methods for the safe use of the chair that are best suited to your level of function and ability.
4. Have someone help you practice bending, reaching and transferring until you learn how to do them safely.
5. **Never** try a new maneuver on your own unless you are sure it is safe.
6. Get to know the areas where you plan to use your chair. Look for hazards and learn how to avoid them.

B. NOTICE TO ATTENDANTS**⚠ WARNING**

Make sure you heed all warnings and follow all instructions in each section of this manual. (Be aware that warnings that apply to the rider also apply to you).

Notes:

1. You need to work with the rider, and the rider's doctor, nurse or therapist, to develop safe methods best suited to your abilities and those of the rider.
2. To manually push the chair you must release the motor locks.
 - Make sure you have full control over the chair when you release the motor locks. When you do so the chair will not have brakes.
3. Propel this chair by the push handles only. They provide secure points for you to hold the rear of the chair to prevent a fall or tip-over.
 - Check to make sure push handle grips will not rotate or slip off.

HELPING THE RIDER OVERCOME AN OBSTACLE:

1. To prevent injury to your back, use good posture and proper body mechanics. When you lift or support the rider or tilt the chair, bend your knees slightly and keep your back as upright and straight as you can.
2. Before each maneuver, tell the rider what you plan to do, and explain what you expect the rider to do. This will put the rider at ease and reduce the risk of an accident.
3. Go straight up and straight down a curb or stair. If you turn, or climb or descend at an angle, a fall or tip-over is likely.
4. Remind the rider to **lean back** when you tilt the chair backward.
5. Lower the chair slowly. Do not let the chair drop to the pavement or ground. Doing so may damage the chair or injure the rider.

C. WEIGHT LIMIT**⚠ WARNING**

1. Never exceed a total weight of 150 pounds (68 kilograms) for rider plus items carried.
2. Never use this chair for weight training if the total weight (rider plus additional weights) exceeds 150 pounds.
3. Exceeding the weight limit is likely to damage the seat, frame, or fasteners, and may cause severe injury to you or others from chair failure.
4. Exceeding the weight limit will void the warranty.

D. CONTROLLER SETTINGS**⚠ WARNING**

Be aware that you may need to adjust the controller settings of your chair to reduce the risk of a collision, fall or tip-over.

1. Check and adjust the settings every six to twelve months (or more often, if needed).
2. Consult your supplier to adjust the control settings immediately if you notice any change in your ability to:
 - Control the joystick.
 - Hold your torso erect.
 - Avoid running into objects.

E. EMI**⚠ WARNING**

Read Section V to learn about EMI. To reduce the risk of unintended brake release or chair movement:

1. Never turn on or use a hand-held transceiver while power to your chair is on. Use extra care if you believe that such a device may be in use near your chair.
2. Be aware of nearby radio or TV stations, and avoid coming close to them.
3. If unintended movement or brake release occurs, turn your chair off as soon as it is safe.

F. SAFETY CHECK-LIST**⚠ WARNING**

Before each use of this chair:

1. Make sure the chair operates smoothly. Check for noise, vibration, or a change in ease of use. (They may indicate low tire pressure, loose fasteners, or damage to your chair).
 - If you detect a problem, make sure to repair or adjust the chair. Your supplier can help you find and correct the problem.
2. Make sure batteries are charged. Green lights on charge indicator will light up when charge is full. Yellow lights indicate battery charge level is getting low. Red lights indicate batteries are in immediate need of charging.

G. CHANGES & ADJUSTMENTS**⚠ WARNING**

Never use non-Quickie parts or make a changes to your chair unless authorized by Sunrise. (Doing so will void the Warranty, and may create a safety hazard).

1. If you modify or adjust this chair it may increase the risk of a fall or tip-over.
2. Modifications unauthorized by Sunrise constitutes remanufacturing of the wheelchair. This voids the warranty. The rider then assumes all future liability for the wheelchair.

H. WHEN SEATED IN A PARKED WHEELCHAIR

⚠ WARNING

1. Always **turn off** all power to your chair when you are parked, even for a moment. This will prevent:
 - Accidental movement from contact with the joystick by you or others.
 - Unintended brake release or movement from EMI sources. (See Section V)
2. Make sure that persons who help you (for example, store clerks) are aware of the joystick and do not touch it. If they do, your chair may move suddenly when you do not expect it.

I. ENVIRONMENTAL CONDITIONS

⚠ WARNING

Your chair is not designed for use in a heavy rain storm, or in snowy or icy conditions.

1. Contact with water or excessive moisture can cause an electrical malfunction. The frame, motors and other chair parts are not water-tight and may rust or corrode from the inside. To avoid a chair failure:
 - Minimize exposure of your chair to a rain storm or very wet conditions.
 - Never take your chair into a shower, tub, pool or sauna.
 - Do not use your chair in fresh or salt water (such as at the edge of a stream, lake, or ocean).
 - Make sure battery covers are secure.
 - Replace joystick boot if it becomes torn or cracked.
 - Make sure all electrical connections are secure.
 - Dry the chair as soon as you can if it gets wet or if you use water to clean it.
2. Proceed slowly and use extra care if you must operate your chair on a wet or slick surface.
 - Do so only if you are sure it is safe.
 - Stop if one or both main wheels lose traction. If this occurs, you may lose control of your chair or fall.
 - Never operate your chair on a slope or ramp if there is snow, ice, water or oil film present.
 - When in doubt, have someone help you.
3. When not in use, keep your chair in a clean, dry place.

⚠ WARNING

Extra caution should be used when employing either the disc switch or the proximity head array as control devices. These two devices are susceptible to malfunction when wet.

J. TERRAIN

⚠ WARNING

1. This chair is designed for use on firm, even surfaces such as concrete, asphalt and indoor flooring.
2. Do not operate your chair in sand, loose soil or over rough terrain. Doing so may damage wheels, bearings, axles or motors, or loosen fasteners.

K. STREET USE

⚠ WARNING

In most states, power chairs are not legal for use on public roads. Be alert to the danger of motor vehicles on roads or in parking lots.

1. At night, or when it is hard to see, use reflective tape on your chair and clothing.
2. It may be hard for drivers to see you. Make eye contact with drivers before you proceed. When in doubt, yield until you are sure it is safe.

L. MOTOR VEHICLE SAFETY

⚠ WARNING

If your chair is NOT equipped with the Transit Tie-down option: Quickie Z-500 wheelchairs do not meet federal standards for motor vehicle seating.

1. Never sit in this chair while in a moving vehicle. In an accident or sudden stop you may be thrown from the chair.
 - Wheelchair belts are designed to position the rider only and will not protect you in an accident; further injury may result from the belts.**
2. Always move to an approved vehicle seat. You must be secured with proper motor vehicle restraints.
3. Never transport this chair in the front seat of a vehicle. It may shift and interfere with the driver.
4. Always secure this chair so that it cannot roll or shift.
 - If your chair is equipped with the Transit Tie-Down Option: see the Transit Tie-Down owners manual for appropriate warnings, set-up and usage.

M. CENTER OF BALANCE

⚠ WARNING

The point where this chair will tip forward, back, or to the side depends on its center of balance and stability.

The Center Of Balance Is Affected By:

1. The seat height and seat angle.
2. A change in your body position, posture or weight distribution.
3. Using this chair on a ramp or slope.
4. The use of a back pack or other options, and the amount of added weight.

To Reduce The Risk Of A Fall Or Tip-Over:

1. Consult your supplier for information on modifications authorized by Sunrise before you modify or adjust this chair.
NOTE– You may need to make additional changes to correct the center of balance.
2. Use extreme care until you know the balance points of this chair and how to avoid a fall or tip-over.

N. TRANSFERS** WARNING**

It is dangerous to transfer on your own. It requires good balance and agility. Be aware that there is a point during every transfer when the wheelchair seat is not below you. To avoid a fall:

1. Always turn off power before you transfer to or from your chair. If you fail to do so you may touch the joystick and cause your chair to move when you do not expect it.
2. Make sure motor locks are engaged. This keeps the chair from moving when you transfer.
3. Work with your health care professional to learn safe methods.
 - Learn how to position your body and how to support yourself during a transfer.
 - Have someone help you until you are sure you can do a safe transfer on your own.
4. Move your chair as close as you can to the seat you are transferring to. If possible, use a transfer board.
5. Rotate the front casters until they are as far forward as possible.
6. Be careful of the footrests. If you can, remove or swing them out of the way.
 - Never stand on footrests when you transfer. Doing so may damage them or cause your chair to tip.
 - Make sure your feet do not “hang up” or get caught in the space between the footrests.
7. Make sure armrests do not interfere.
8. Transfer as far back onto the seat surface as you can. This will reduce the risk that you will miss the seat or fall.

O. REACHING OR LEANING** WARNING**

Reaching or leaning affects the center of balance of your chair. If done improperly, a fall or tip-over is likely. When in doubt, ask for help or use a device to extend your reach.

To Reduce the Risk of Injury and/or Damage to the Chair:

1. Never reach or lean if you must shift your weight sideways or rise up off the seat.
2. Never reach or lean if you must move forward in your seat to do so. Always keep your buttocks in contact with the backrest.
3. Never reach with both hands (you may not be able to catch yourself to prevent a fall if you lose your balance).
4. Never try to pick up an object from the floor by reaching down between your knees.
5. Never put pressure on the footrests while reaching. This may cause the chair to tip if you lean too far.
6. Never reach or lean over the top of the seat back. This may damage the backrest and cause you to fall.

IF YOU MUST REACH OR LEAN; DO SO AT YOUR OWN RISK.**Remember to:**

1. Move your chair as close as you can to the object you wish to reach.
2. Rotate the front casters until they are as far forward as possible. This makes the chair more stable.
NOTE– To do this: Move your chair past the object you want to reach, then back up alongside it. Backing up will rotate the casters forward.
3. Turn off all power to your chair. If you fail to do so, you may touch the joystick and cause your chair to move when you do not expect it.
4. Firmly grasp a rear wheel or an armrest with one hand. This will help to prevent a fall if the chair tips.

P. DRESSING OR CHANGING CLOTHES** WARNING**

Be aware that your weight will shift if you dress or change clothes while seated in this chair. To make the chair more stable, rotate the front casters until they are **forward**.

Q. OBSTACLES

⚠ WARNING

Obstacles you may have to overcome in daily use include door thresholds, lifts, ramps and hazards such as potholes and broken pavement. These can damage your chair and may cause a fall, tip-over or loss of control.

1. Be aware that thresholds are very dangerous. (Even a small change in height may stop a caster wheel and cause your chair to tip). You may need to:
 - Remove or cover threshold strips between rooms.
 - Install a ramp at entry or exit doors.
2. Keep your eyes moving when you ride; scan the area well ahead of your chair.
3. Make sure the floor areas where you use this chair are level and free of obstacles.
4. To help correct your center of balance:
 - Lean your upper body **forward** slightly as you go **up** over an obstacle.
 - Press your upper body **backward** as you go **down** from a higher to a lower level.

R. DRIVING IN REVERSE

⚠ WARNING

Use extra care when you drive your chair in reverse. You may lose control or fall if one of the rear wheels hits an object.

1. Operate your chair slowly and at an even speed.
2. Stop often and check to make sure your path is clear of obstacles.

S. RAMPS, SLOPES & SIDEHILLS

⚠ WARNING

The center of balance of your chair changes when you are on a slope.

NOTE– “Slope” includes a ramp or sidehill. Your chair is less stable when it is at an angle. Never use this chair on a slope unless you are sure it is safe. When in doubt, have someone help you.

Beware Of:

1. Steep slopes. Do Not use this chair on a slope steeper than 10%. (A 10% slope means: One foot in elevation for every ten feet of slope length).
2. Wet or slippery surfaces (such as when ice, snow, water or oil film is present). A loss of traction may cause a fall or tip-over.
3. A change in grade on a slope (or a lip, bump or depression). These may cause a fall or tip-over.
4. A drop-off at the bottom of a slope. (A drop-off of as small as 3/4 inch can stop a front caster and cause the chair to tip forward).

T. TO REDUCE THE RISK OF A FALL, TIP-OVER OR LOSS OF CONTROL

⚠ WARNING

1. Never use your chair on a slope unless you are sure you can do so without losing traction.
 - Do not “cut the corner” on a slope or ramp.
 - Do not turn or change direction on a slope.
2. Always go as straight up and as straight down as you can.
 - Always stay in the center of the ramp. Make sure ramp is wide enough that you are not at risk that a wheel may roll off the side.
3. Always stay in the center of the ramp. Make sure ramp is wide enough that you are not at risk that a wheel may roll off the side.
4. Lean or press your body uphill. This will help adjust for a change in the center of balance caused by the slope. (Fig. 1)
5. Keep your chair moving at a slow, steady speed. Keep control over the chair at all times.
 - On a descent, do not let your chair accelerate beyond its normal speed.
 - If the chair picks up speed, center the joystick to slow down or stop.

NOTE– The solid state controller of your chair has a logic system that will help control your speed when driving on a slope or uphill.

 - If you stop, re-start slowly.
6. Never use rear wheel locks to try to slow or stop your chair. This is likely to cause the chair to veer out of control.

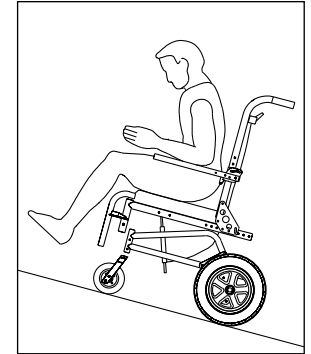

Fig. 1

U. RAMPS AT HOME & WORK

 **WARNING**

Make sure ramps meet all Building Codes for your area.

1. For your safety, have a licensed contractor build or remodel ramp to meet all standards.
2. **NOTE**– The proper design will vary, depending on such things as: the length and height of the ramp; the need for an intermediate platform; landing size; doors and the direction of swing; and whether the ramp includes a turn or angle.

At A Minimum:

1. Open sides of ramp must have side rails to prevent your chair from going over the edge.
2. Slope must not be steeper than one inch in height for every one foot of slope length.
3. Ramp surface must be even and have a non-skid surface.
4. You may need to add a section at the top or bottom to avoid a lip or drop-off.
5. Ramp must be sturdy. Add bracing if needed, so ramp does not “bow” when you ride on it.

V. WHEELCHAIR LIFTS

 **WARNING**

Wheelchair lifts are used in vans, buses, and buildings to help you move from one level to another.

1. Always turn **off** all power to your chair when you are on a lift. If you fail to do so, you may touch the joystick by accident and cause your chair to drive off the platform. (Be aware that a “roll-stop” at the end of the platform may not prevent this).
2. Make sure there is not a lip or drop-off at the top or bottom of the platform. These may cause a fall or tip-over. When in doubt, have someone help you.
3. Be sure individual is securely positioned before transporting to a lift and into the vehicle.
4. Avoid moving forward if a wheel is “hung up” on the lip of the ramp. Backup, reposition the caster for a more direct approach. Slowly try again.

W. CURBS & SINGLE STEPS

 **WARNING**

1. Your chair is not designed to drive up or down a curb or step more than two (2) inches high. Doing so may:
 - Result in a fall or tip-over.
 - Damage the frame, wheels, axles or other chair parts, or loosen fasteners.
2. To prevent a fall or tip-over, use wheelchair access ramps or have someone help you.
3. If you must climb or descend a curb or step alone do so at your own risk and use extreme care.
 - Go as straight up or straight down as you can. **Never** turn or climb or descend at an angle as a fall or tip-over is likely.
 - Proceed slowly, at a steady speed.
4. Make sure that persons who assist you review the “Tips For Attendants” and heed all warnings.

X. STAIRS

 **WARNING**

Never use this chair to go up or down stairs, even with an attendant. Doing so is likely to cause a fall or tip-over.

Y. ESCALATORS

 **WARNING**

Never take this chair on an escalator, even with an attendant. Doing so is likely to cause a fall or tip-over.

⚠ WARNING

If you use parts or make changes not authorized by Sunrise it may create a safety hazard and will void the Warranty.

A. ANTI-TIP LEVERS**⚠ WARNING**

Never remove or alter anti-tip levers. They help keep your chair from tipping over backward in normal use. Make sure rubber rollers are in good condition.

B. ARMRESTS**⚠ WARNING**

Armrests detach and will not bear the weight of this chair.

1. **Never** lift this chair by its armrests. They may come loose or break.
2. Lift this chair only by non-detachable parts of the main frame.

C. BATTERIES**⚠ WARNING**

1. Only **deep cycle sealed case** construction batteries should be used in this device.
2. To prevent an acid spill, always keep batteries **upright** (wet batteries).
3. **Never** smoke or hold an open flame near batteries. They are a known explosion hazard.
4. Always wear rubber gloves and safety glasses when you handle batteries.
5. Read all of section **XI Batteries** before attempting to change, or charge batteries.

D. CUSHIONS & SLING SEATS**⚠ WARNING**

1. Quickie sling seats, standard foam cushions, and other body supports are not designed for the relief of pressure.
2. If you suffer from pressure sores, or if you are at risk that they will occur, you may need a special seat system or a device to control your posture.
 - Consult your doctor, nurse or therapist to find out if you need such a device for your well-being.

E. FASTENERS**⚠ WARNING**

Many of the screws, bolts and nuts on this chair are special high-strength fasteners. Use of improper fasteners may cause your chair to fail.

1. **Only** use fasteners provided by Sunrise.
2. If fasteners become loose, tighten them as soon as you can.
3. Over- or under-tightened fasteners may fail or cause damage to chair parts.
 - See Section IX for proper torque settings.

F. FOOTRESTS**⚠ WARNING**

1. At the lowest point, footrests should be at least 2 1/2 inches off the ground. If set too LOW, they may “hang up” on obstacles you can expect to find in normal use. This may cause the chair to stop suddenly and tip forward.
2. To avoid a trip or fall when you transfer:
 - Make sure your feet do not “hang up” or get caught in the space between the footrests.
 - Avoid putting weight on the footrests, as the chair may tip forward.
 - Remove or swing the footrests out of the way, if possible.
3. **Never** lift this chair by the footrests. Footrests detach and will not bear the weight of this chair. Lift this chair only by non-detachable parts of the main frame.

G. MOTOR LOCKS**⚠ WARNING**

1. Do not engage or disengage motor locks **unless** power to the chair is **off**.
2. Be aware that the chair **will not have brakes** when motor locks are in the free-wheel position.
3. Make sure that the person pushing the chair has full control when motor locks are disengaged.

H. ON/OFF SWITCH**⚠ WARNING**

1. **Never** use the ON/OFF switch to stop the chair **except** in an emergency. This will result in an **abrupt** stop, and may cause you to fall.
2. To slow your chair to a stop, return the joystick to neutral.

I. PNEUMATIC TIRES**⚠ WARNING**

- Proper inflation extends the life of your tires and makes your chair easier to use.
1. Do not use this chair if any of the tires are under- or over-inflated. Check weekly for proper inflation level, as listed on the tire sidewall.
 2. Low pressure in a tire may cause the chair to veer to one side and result in a loss of control.
 3. An over-inflated tire may burst.
 4. **Never** use a gas station air pump to inflate a tire. Such pumps provide air at **high volume**, and could cause the tire to burst. To prevent tire damage:
 - Use a hand pump (or a **low volume** air pump) to inflate tires.
 - Use a tire gauge to check pressure.
 5. Driving over sharp objects may cause damage to pneumatic tires and tubes.

J. POSITIONING BELTS (OPTIONAL)**⚠ WARNING**

Use a positioning belt only to help support your posture. Improper use of such belts may cause severe injury or death.

1. Make sure you are not at risk to slide down in the wheelchair seat. If this occurs, you may suffer chest compression or suffocate due to pressure from the belt.
2. A pelvic wedge or a similar device can help keep you from sliding down in the seat. Consult your health care professional to find out if you need such a device.
3. The belt must be snug, but must not be so tight that it interferes with breathing. You should be able to slide your open hand, flat, between the belt and your stomach.
4. Make sure you can easily remove the belt in an emergency.
5. **Never** use a positioning belt:
 - In place of a motor vehicle seat belt. In an accident or sudden stop you may be thrown from the chair. A positioning belt will not prevent this, and further injury may result from the belt.
 - As a restraint. A restraint requires a doctor's order.
 - On a rider who is comatose or agitated.

K. PUSH HANDLES**⚠ WARNING**

1. Push handles provide secure points for an attendant to propel and control the chair. This helps to prevent a fall or tip-over.
2. Check to make sure push handle grips will not rotate or slip off.

L. REAR WHEEL LOCKS (OPTIONAL)**⚠ WARNING**

If you request them, we will install rear wheel locks at Sunrise.

1. Rear wheel locks are **not** designed to slow or stop a moving wheelchair. **Never** apply them when your chair is moving. Doing so may cause you to veer out of control.
 - Use wheel locks **only** to keep the rear wheels from rolling when your chair is at a complete stop.
2. Low pressure in a rear tire may cause the wheel lock on that side to slip and may allow the wheel to turn when you do not expect it.
3. Make sure lock arms embed in tires at least 3/8 inch when locked. If you fail to do so, the locks may not work.

M. SEATING SYSTEMS**⚠ WARNING**

1. Use of a seating system not approved by Sunrise may alter the center of balance of this chair. This may cause a fall or tip-over.
2. **Never** change the seating system of your chair **unless** you consult your supplier first.

N. UPHOLSTERY FABRIC**⚠ WARNING**

1. Replace worn or torn seat sling or seat back fabric as soon as you can. If you fail to do so, the seat may fail and cause you to fall. Worn fabrics may increase the potential for a fire hazard.
2. Sling fabric will deteriorate with age and use. Look for fraying, thin spots, or stretching of fabric at rivet holes. Replace fabric as required.
3. "Dropping down" into sling seat will weaken fabric and result in the need to inspect and replace sling on a more frequent basis.
4. Be aware that washing may reduce flame retardation of the fabric.

⚠ WARNING

1. Persons who help a rider do one of the following tasks should review and heed the warnings "Notice to Attendants" and all warnings in this Manual for that task.
2. The "Tips" that follow are suggestions only. Be aware that you will need to learn safe methods best suited to the rider and to your abilities. Consult your health care professional for instructions.

A. TO CLIMB A CURB OR SINGLE STEP**⚠ WARNING**

The following is one way to safely help a rider climb a curb or single step going **forward**:

1. Stay behind the chair.
2. Face the curb and tilt the chair up on the rear wheels so that the front casters clear the curb or step.
3. Move forward, placing the front casters on the upper level as soon as you are sure they are past the edge.
4. Continue forward until the rear wheels contact the face of the curb or step. Lift and roll the rear wheels to the upper level.

B. TO DESCEND A CURB OR SINGLE STEP**⚠ WARNING**

The following is one way to safely help a rider descend a curb or single step going **backward**:

1. Stay at the rear of the chair.
2. Several feet before you reach the edge of the curb or step, turn the chair around and pull it backward.
3. Proceed carefully. Look over your shoulder and carefully step back until you are off the curb or stair and standing on the lower level.
4. Pull the chair toward you until the rear wheels reach the edge of the curb or step. Then allow the rear wheels to slowly roll down onto the lower level.
5. When the rear wheels are safely on the lower level, tilt the chair back to its balance point. This will lift the front casters off the curb or step.
6. Keep the chair in balance and take small steps backward. Be sure to look where you are going. Turn the chair around and gently lower front casters to the ground.

NOTES**1. Work Surface For Set-Up:**

Use a flat surface, such as a table, to assemble, adjust and check your chair. This makes the steps easier and helps ensure a correct set-up.

2. Fasteners:

- Many of the screws and bolts on this chair are special high-strength fasteners and may have special coatings.
- Many nuts are of the Nylock type. They have a plastic insert to help prevent loosening.
- Only use screws, bolts and nuts provided by Sunrise.

⚠ WARNING

1. Use of improper fasteners may cause the chair to fail.
2. Over- or under-tightened fasteners may fail or cause damage to chair parts.
3. If bolts or screws become loose, tighten them as soon as you can. Loose bolts or screws can cause damage to other chair parts causing them to fail.

3. Washers & Spacers:

- Note the position of washers and spacers before disassembly.
- To avoid damage to the frame, replace all washers and spacers when you reassemble parts.

4. Torque Settings:

- A torque setting is the optimal tightening for a particular fastener. Use a torque wrench that measures inch-pounds to secure screws, nuts and bolts on this chair.

NOTE– Unless otherwise noted, use a torque setting of 120 inch-pounds for all fasteners.

TOOLS YOU WILL NEED**1. Basic Tool Kit:**

To set-up, adjust and maintain your chair you will need the following tools:

- 7/16" box and open-end wrench
- 1/2" box and open-end wrench
- 3/4" box and open-end wrench
- 5/32" Allen wrench
- 3/16" Allen wrench
- Phillips screwdriver #2
- Custom axle wrench (or a 1/2" open-end wrench)

You can obtain a multi-purpose tool kit from Sunrise, or buy the tools you need from a hardware store.

2. Torque Wrench:

If you plan to adjust and maintain this chair yourself, Quickie recommends that you use a torque wrench.

NOTE– The wrench must measure inch-pounds. You can buy a torque wrench and proper sockets from a hardware store.

CHECK-OUT

Be sure this chair performs to your chosen operational settings. If it does not, turn the chair off immediately and reprogram with the Quickie QTRONIX Programmer. If you do not own a Quickie QTRONIX Programmer have your supplier reprogram your wheelchair as needed. Or, you can order a Quickie QTRONIX Programmer for your own use, from your supplier.

NOTE– Repeat this procedure until the chair performs to your specifications

⚠ WARNING

When properly set-up, this chair will operate smoothly. Check to see that all components work properly. If you detect a problem, be sure to correct it before use.

A. SWING-AWAY FOOTRESTS**1. Installation**

- Place swing-away pivot saddle (A) into the receiver (B) on front frame tube with the footrest facing outward from the frame.
- Rotate the footrest inward until it locks into place on locking bolt.

2. Removal

- To remove footrest, push release latch (C) toward the frame.
- Rotate footrest outward, and lift.

3. Height-Adjustment

- Loosen set screws (D).
- Slide footrest extension up or down inside frame tube to desired height.
- Tighten set screws.

4. Footplate Angle-Adjustment

- Loosen the retaining bolt (E) in the frame tube.
- Reposition footplate to desired angle.
- Tighten bolt.

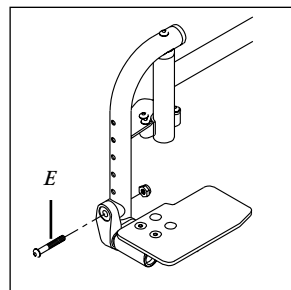
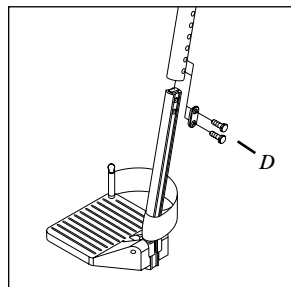
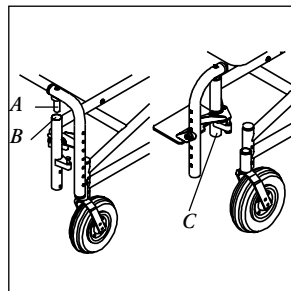
**B. 90° FOOTBOARD****1. Height-Adjustment**

- Loosen the four clamp bolts (A) underneath the footboard assembly.
- Position footplate at desired height.
- The adjustment on each side of the footrest should be of equal height.
- Tighten nuts.

2. Angle-Adjustment

- Loosen the four nuts (B) underneath the footboard assembly until the mounting tubes rotate freely.
- Adjust mounting tube length, by sliding the tubes inward or outward so it slides easily into the sleeves.
- Adjust the angle of the footboard.
- Slide it forward or backward for correct placement.
- Tighten nuts.

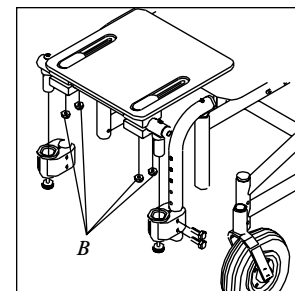
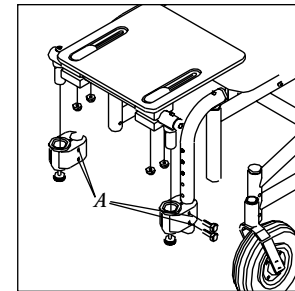
**C. ARTICULATING LEGREST (OPTIONAL)****1. Installation**

To install or remove Articulating Legrest (ALR) see instructions for Swing-away Footrest installation on page 28.

2. Adjustment

- To raise legrest, lift to desired position. Legrest will automatically lock in place.
- To lower legrest, while seated in chair, first lift slightly then lift release lever (A) up and lower legrest to desired position. Legrest will automatically lock in place.

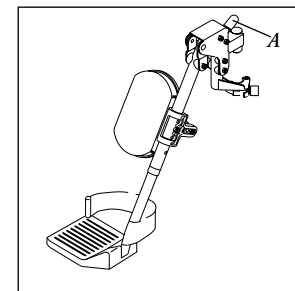

Articulating Legrests

D. ELEVATING LEGREST (OPTIONAL)**1. Installation**

To install or remove Elevating Legrest (ELR) see instructions for Swing-away Footrest installation on page 28.

2. Adjustment

- To raise legrest, lift to desired position. Legrest will automatically lock in place.
- To lower legrest, while seated in chair, lift legrest slightly while pressing release lever (B) down and lower legrest to desired position. Legrest will automatically lock in place.

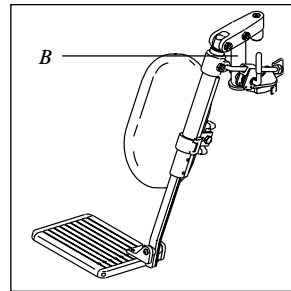
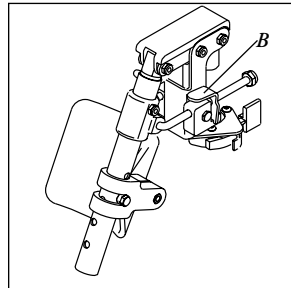
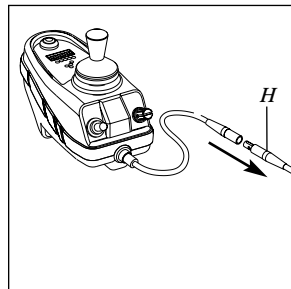
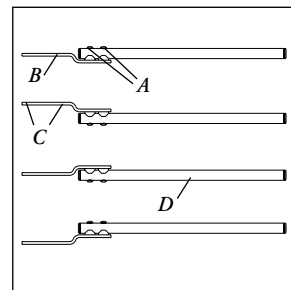
*Elevating Legrests**90° Elevating Legrests**Remote Joystick***E. REMOTE JOYSTICK INSTALLATION****1. To Connect**

- Line up small cylindrical connector with its receptacle on the rear of the joystick.
- Push in firmly.

2. To disconnect

Pull back on the retaining ring (H) of the cylindrical connector until it disconnects from the joystick box.

F. TO ADJUST THE HEIGHT OF THE REMOTE JOYSTICK

- Remove the two pan-head screws (A), securing the angle bracket mount (B).
- Remove the Joystick from the mount by unfastening the two screws (C) on the underside of the mount.
- Position angle bracket mount such that you achieve the desired joystick height. Four positions are available by relocating the mount either on the top or bottom of the mounting bar (D) and/or by rotation of the angle bracket mount.

G. REMOTE JOYSTICK SWING-AWAY RETRACTABLE MOUNT (OPTIONAL)

The remote joystick is mounted with a mechanism which allows the control to be locked in a forward or retracted position using magnets.

Adjustment

- To retract joystick, push outward on the inside of joystick.
- Push joystick away from front of armrest until it locks into retracted position.
- To return to forward position, push joystick forward until it locks into place.

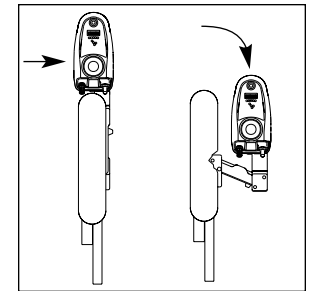
**H. SOLID BACK AND SEAT INSERT****1. Installation**

- Place the solid back hook clamps (A) on the push handles.
- Position solid seat on the top of front frame and press down until the saddles (B) are secured on the frame.
- Insert the quick-release pins (C) through the mounting hole on the hook clamps.

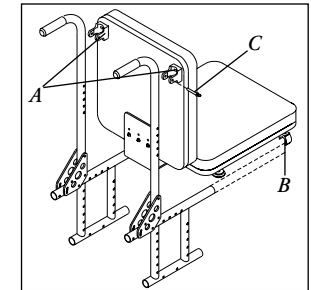
**I. WHEEL LOCKS**

Quickie wheelchairs are shipped with high-mount wheel locks. Wheel locks are installed at Sunrise unless you have requested otherwise.

Use a torque setting of 100 in./lbs when setting-up wheel locks.

1. High-Mount Wheel Lock:

- Loosen the screws on the top of each clamp. Do not attempt to remove one screw at a time.
- Slide assembly toward rear wheel until clamp (D) embeds into tire to prevent wheel movement when in locked position.
- Adjust angle position.
- Tighten screws.

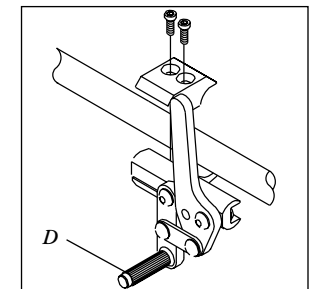

J. HEIGHT-ADJUSTABLE ARMRESTS (OPTIONAL)

1. Installation

- Slide the outer armpost into the receiver mounted to the wheelchair frame.
- The armrest will automatically lock into place.

2. Height Adjustment

- Rotate release lever to second stop.
- Slide armrest pad up or down to desired height.
- Return lever to locked position against armpost.
- Push arm pad until upper armpost locks firmly into place.

3. Removing Armrest

- Rotate release lever to first stop and remove the armrest.

4. Replacing Armrest

- Slide armrest back into receiver.
- Return release lever to locked position against armpost.

5. Adjusting Armrest Receiver Fit

To tighten or loosen the fit of the outer armpost in the receiver:

- Loosen the four bolts on the sides of the receiver.
- With the armrest in the receiver, squeeze the receiver to achieve the desired fit.
- Tighten the four bolts.

6. Adjusting Inner Armpost Fit

- Two set screws are installed in the outer armpost.
- Turn the set screws in or out until the desired fit is achieved.

K. ADJUSTABLE LOCKING FLIP-UP ARMREST (OPTIONAL)

1. Adjustment

- Loosen clamp bolts.
- Move clamp up or down backrest posts to desired position.
- Tighten bolts.

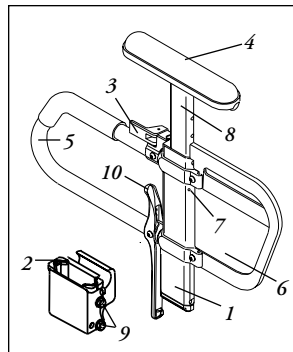

Height-Adjustable

Armrest Key

- Outer armpost
- Standard receiver
- Release lever
- Armrest pad
- Transfer bar
- Side panel
- Outer armpost tension adjustment set screws
- Inner armpost
- Receiver adjustment bolts
- Release Lever

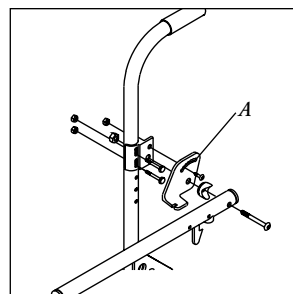

2. Angle-Adjustment

- Loosen bolt.
- Set armrest at desired angle using preset holes in armrest angle (A) plate.
- Tighten bolt.

L. SEAT DEPTH

The solid back has an adjustment range of 6".

1. Adjustment

- Remove the two bolts securing the backrest pivot onto the seat frame.
- Position the backrest pivot plate in the pre-drilled holes on the frame.
- Replace bolts and tighten securely.

NOTE– This adjustment may also require repositioning the seat-to-back bracket (underneath the solid seat) into the second set of mounting holes.

M. TILT-IN-SPACE MECHANISM

The tilt-in-space mechanism is installed at Sunrise. A cable trigger mechanism positively locks in place from 90° to 145°.

1. Adjustment

- Loosen jam by turning it clockwise.
- Turn the cable adjuster piece until looseness is removed from cable.
- Tighten jam nut.

NOTE– With 15" and 16" frames two tilt-in-space mechanisms are required.

N. NONTILT

A 15" angle-adjustment is standard on all Quickie Z-500 wheelchairs with a nontilt option.

1. Nontilt Bracket Adjustment

- Remove the lower securing bolt (A) on the nontilt bracket.
- Set at desired angle. There are five holes (in 3" increments) to choose from.
- Reinstall the bolt and tighten securely.

IMPORTANT NOTE– Do not position the front seat height lower than the rear.

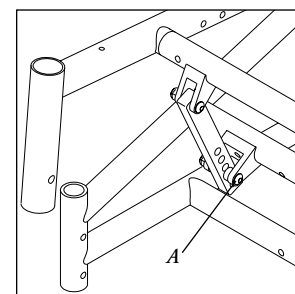
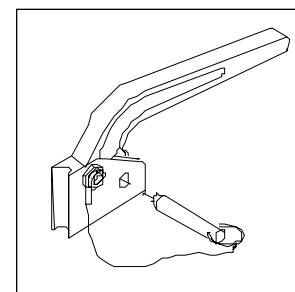
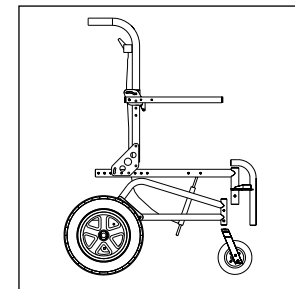
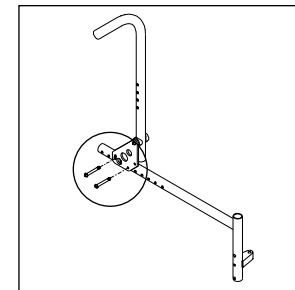

O. STRUT TUBES

1. Width Adjustment

- Replace the three strut tubes and release bar with larger or smaller sizes. Strut tubes and release bars are available from your authorized supplier.

NOTE ON WIDTH ADJUSTMENT– Size changes may require a larger seat insert and footplates. 15" and 16" widths receive adult hangers.

P. CHECK-OUT

After the wheelchair is assembled and adjusted, it should roll smoothly and easily. All accessories should also perform smoothly. If you have any problems, follow these procedures:

- Review Set-up, Adjustment & Use sections to make sure chair was properly prepared.
- If your problem persists, contact your authorized supplier. If you still have a problem after contacting your authorized supplier, contact Sunrise customer service. See the introduction page for details on how to contact your authorized supplier or Sunrise customer service.

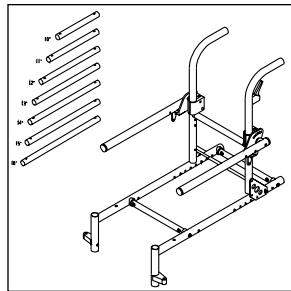

A. PERFORMANCE CONTROL SETTINGS

- It is vital to match control settings to your level of function and ability.
- Consult your health care professional and your supplier to select the best control settings for you.
- Check and adjust the settings every six to twelve months (or more often, if needed).
- Adjust the control settings **immediately** if you notice any change in your ability to:
 - Control the joystick.
 - Hold your torso erect.
 - Avoid running into objects.
- Control Settings are adjusted through the use of the Quickie QTRONIX Programmer. See your supplier if you do not own a Quickie QTRONIX Programmer pad.

B. QTRONIX PROGRAMMING PAD (OPTIONAL)

⚠ WARNING

Program settings beyond the ability of the rider can result in serious injury. Consult your health care advisor before you alter settings.

1. Notes:

The Qtronix Programmer lets you adjust the control settings of the Z-500. You can customize a program for yourself or select the standard program.

- acceleration rate
- deceleration rate
- turn acceleration
- turn deceleration
- forward speed (max & min)
- reverse speed (max & min)
- turn speed (max & min)
- steer correct
- 4-axis joystick throw
- sleep timer

2. To Program Your Chair:

- Turn **off** power to the chair.
- Insert Qtronix Programmer plug (A) into the Programmer/Charger socket on the front of the remote joystick.
- Turn **on** power to the chair; program as needed.
- Remove plug and cycle ON/OFF switch to drive chair.

NOTE– Review the Qtronix Programmer Owner's Manual for more details on how to program your chair.

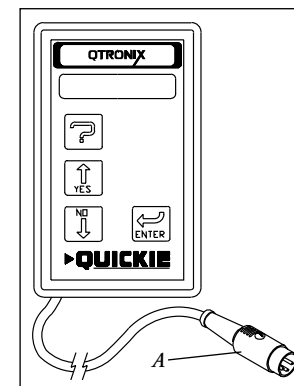

NOTE– Program settings that are not matched for the capabilities of the rider can result in serious injury. Do not alter settings without the advice of your health care professional.

C. THERMAL ROLL-BACK

Your chair has a thermal roll-back circuit. This protects the controller from damage due to overheating. In extreme conditions (such as repetitive hill climbing) the circuit will decrease the power to your motors. This allows the chair to operate at a reduced speed. When the controller cools, the chair will return to normal speed.

D. CIRCUIT BREAKERS

1. Notes:

Your Quickie Z-500 has two battery boxes, with a circuit breaker on each box.

- In the unlikely event of a short circuit or heavy overload, all power to your chair will be shut off.
- To reset your chair, depress the circuit breaker button(s) on the front of the battery boxes. A few minutes wait is required before the circuit breaker(s) will reset.

2. Repeated Shutdown

If the chair continues to shut down after resetting, have it serviced by a supplier.

E. JOYSTICK ASSEMBLY

The joystick connects to a controller, which controls the chair's performance. The joystick assembly consists of the following parts:

1. Speed Control Knob (A)

Use the speed control knob to adjust the maximum speed of your chair. Turn it counter-clockwise to reduce speed; turn it clockwise to increase speed.

2. Battery Charge Indicator (B)

- Green lights indicate that batteries are fully charged.
- Yellow lights indicate that batteries need recharging.
- When the lights stay in the red band, the batteries must be recharged.

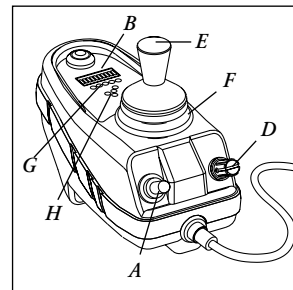
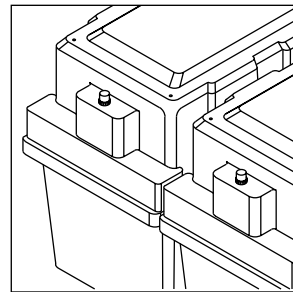

Remote Joystick

3. On/Off switch (D)

The on/off/mode switch is located on the rear face of the joystick housing. It is a toggle switch. Turning the chair on or off is accomplished by pressing the switch downward. The switch will automatically return to the center point. Alternate locations exist for this switch. Please see your supplier in the event that you wish to relocate or re-orient this switch.

4. Mode Switch (D)

The on/off/mode switch allows you to select from 5 (five) different programmable drive profiles or actuator mode sets.

- Push up the on/off/mode select toggle switch to index among the five drive and actuator modes. The selected mode indicator will flash.
- Push joystick either left or right to select one of the five drive profiles. To select the actuator modes, push the mode select switch twice.
- The drive profiles are indicated by the mode indicators (G) and the actuators are indicated by the four actuator lights (H).
- To exit drive or actuator mode select, simply push the on/off/mode toggle up one or more times until the indicator no longer flashes, or push the joystick forward or reverse to begin driving.

5. JOYSTICK (E)

The joystick controls the direction and speed of your chair. Turn the chair on and move the joystick in the direction you want to go.

- Moving the joystick from the neutral (center) position disengages the motor locks, allowing the chair to move.
- The chair will move faster the more you move the joystick away from neutral.
 - NOTE**– If your speed becomes hard to manage, release the joystick and the chair will come to a complete stop.
- When you release the joystick it will return to neutral; the chair will slow to a stop and the motor locks will reengage.
- We recommend that you switch the chair off if you stop for any length of time. This will conserve battery power.

NOTE– Once the chair stops, switching the chair off will not affect the motor locks.

6. Joystick Boot (F)

Make sure the boot is not torn or cracked (this could allow debris, water or moisture to enter). If the boot is torn or cracked, replace it as soon as you can.

7. Remote Switch Jacks (optional) (I)

Two 1/8" mono jacks are optional to provide remote switch control of the on/off power function and the mode select function. Any of the single switches offered by Sunrise Medical can be used to connect to either or both of these jacks (except the single zero touch switch).

⚠ WARNING

1. **Never use the ON/OFF switch to stop your chair except in an emergency. This will result in an abrupt stop and may cause you to fall.**
2. **To slow or stop your chair, return the joystick to neutral.**

F. MOTOR LOCKS

Disconnect the motor locks when you need to manually push the chair. (For example, in an emergency, or if batteries fail).

⚠ WARNING

1. **Do not disengage motor locks unless power to the chair is off.**
2. **Be aware that the chair will not have brakes in the free-wheel position.**
3. **Make sure that the person pushing the chair has full control when motor locks are disengaged.**

1. Disengage Motor Locks

- a. Turn the levers (both left and right side) inward to the free wheel position.

2. Engage Motor Locks

- a. Turn the levers (both left and right side) outward into the drive position.

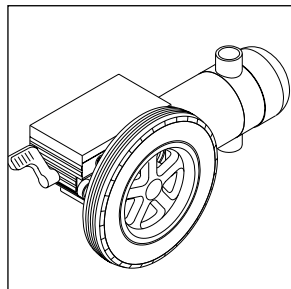
**A. INTRODUCTION****1. Notes:**

- Batteries supply the power for your chair. They contain a finite amount of energy and have limits on how long they can store and supply energy.
- You can charge batteries only a certain number of times before they will fail and no longer hold a charge.
- For answers to questions about batteries, consult your supplier.

2. Use Proper Batteries:

Your chair operates on two 12 volt batteries.

- They should be 22 NF or U1 size with a minimum of 30 ampere hour rating. Only **deep cycle sealed case** construction should be used in this device.
- When you buy a replacement, insist on a deep cycle sealed case type. Do not use a car starter battery.

3. Breaking In:

- A battery requires “breaking-in” for the first 6 to 12 charges. It will not accept a full charge for this period.
- It is best to limit the length of your trips until you break the batteries in and you know the range of your chair.

4. Discharged Batteries:

- **Never** allow a battery to completely discharge. If you operate your wheelchair until it has almost stopped, you will greatly reduce the life of your batteries.
- **Never** let a battery sit in a discharged condition. Give unused or stored batteries a full charge once per month.
- **Always** fully charge the batteries. **Avoid** “topping off” with frequent charges.

⚠ WARNING

Never connect a life support or auxiliary device to a wheelchair battery. The electrical system may fail and result in severe injury to or death of rider.

B. BATTERY CHARGER

A battery charger produces a direct current (DC). When applied to a discharged battery, this reverses the chemical reaction that led to its discharge.

1. Charge Rate. How fast a battery will charge depends on:

- Its electrical capacity; state of charge; electrolyte temperature; and internal condition.
- The DC output of the charger. (The charge rate will vary if the alternating current (AC) supply is higher or lower than 110 volts).

2. Caution — To Avoid Damage to the Charger:

- **Never** place the charger on top of a battery during charging. (Gases from the battery can damage the charger and may lead to an explosion or fire).
- **Never** place a battery on top of the charger.
- **Never** expose charger to rain or snow.

- **Never** unplug charger by pulling on the electrical cord. This will damage the cord.
 - **Never** open a charger or attempt to repair it yourself. Return charger to Sunrise or have repairs made **only** by a qualified person.
 - Keep cord out of the way, where it will not be stepped on, tripped over, or damaged.
- 3. Caution — To Avoid Damage to the Battery:**
- Make sure you use the correct setting for sealed (gel) batteries (located on the off-board charger).
 - **Never** charge a frozen battery. A fully charged battery will rarely freeze, but the fluid in a discharged battery can freeze at 16 degrees Fahrenheit (minus 9 degrees Centigrade). If you suspect a battery is frozen, thaw it before charging.

⚠ WARNING

Lead acid batteries generate explosive gas while charging. Completely read and follow all warnings about the batteries in this user instruction manual and any labels applied to the product. Failure to do so could result in fire, explosion, injury and/or death.

C. ACID BURNS (UNSEALED WET CELL BATTERIES)

Acid in batteries is corrosive. It can cause serious burns to the eyes and skin and can damage floors, furniture, clothing and your wheelchair.

⚠ WARNING

1. Use extreme care not to spill acid when you handle batteries. Keep batteries upright.
2. Avoid contact of acid with bare skin or clothing.
3. Always wear rubber gloves and safety glasses when you handle batteries.
4. If acid contacts your skin or clothing, wash immediately with soap and water.
5. If acid contacts your eyes, immediately flood eyes with cold running water for at least 15 minutes. Seek medical attention immediately.

D. CONNECTING BATTERIES IN BATTERY BOX(ES)

⚠ WARNING

1. Batteries weigh up to 40 lbs. Take care to avoid injury when lifting.
 2. Keep batteries upright. Take care not to spill acid.
 3. Always wear rubber gloves and safety glasses when you handle batteries.
 4. Before working around batteries, remove all metal personal effects such as necklaces, rings, watches, pins, and other metal jewelry that might contact a battery terminal and cause a short.
1. Lift batteries into battery boxes.

⚠ WARNING

Batteries weigh up to 40 pounds. Lifting batteries may cause back strain. If you fail to heed these warnings severe injury may occur to you.

2. Connect the red lead to the positive terminal and the black lead to the negative terminal. Do this for each battery/battery box combination.
3. Tighten all terminal fasteners using two wrenches.
4. Place the battery lids on the bases and secure with the battery box strap.

⚠ WARNING

Never make direct contact across both battery terminals as an explosion may occur. A spark may result in an explosion and/or fire resulting in severe injury or death.

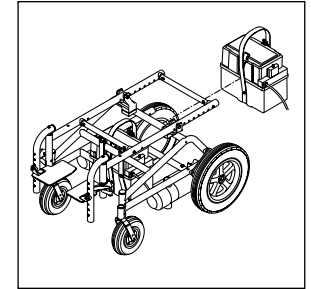

E. CHARGING BATTERIES**⚠WARNING**

To avoid the risk of severe injury or death from electrical shock, fire or explosion while charging:

1. Never connect charger to a 240 volt source. The mains input voltage is 110 volts.
2. Never touch the charger after it is connected to an electrical outlet. This may cause electrical shock.
 - Never connect or disconnect charger from battery while there is power to the charger.
3. Never use an extension cord. Use of an improper cord could damage the charger or cause a fire or electrical shock.
4. A battery emits explosive hydrogen gas during charging. To reduce the risk of fire or explosion:
 - Make sure area is well vented. Never charge battery in a closed-in area.
 - Never smoke or allow a spark, flame or high heat near battery during charging.
 - Never allow metal tools or chair parts to make direct contact across both battery terminals.
5. Never look directly into cells when charging battery.

Always:

1. Use the charger that comes with your wheelchair. Read and follow all instructions and warnings.
2. Make sure room is well ventilated.
3. Turn off all power to your chair.
4. Connect and disconnect battery cables with caution. Only connect the charger to the power supply after the charger has been connected to the chair.

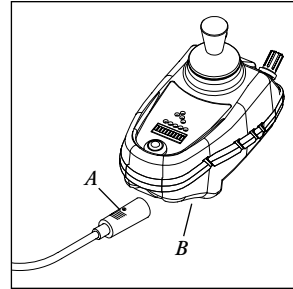

5. Make sure to allow enough time to fully charge batteries.

NOTE– Batteries should never be left for long periods in the discharged state.

Unused or stored batteries should be given a charge once per month.

6. Charge batteries by engaging the battery charger connector (A) to the charger/programming port (B) located on the joystick.

F. DISPOSING OF BATTERIES**⚠WARNING**

1. All batteries once they have reached the end of their useful life are deemed to be hazardous waste.
2. For further information on handling and recycling contact your local recycling authority.
3. Always dispose of product through a recognized agent.

A. NOTES

1. Proper maintenance will improve performance and extend the useful life of your chair.
2. Clean your chair regularly. This will help you find loose or worn parts and will make your chair easier to use.
3. To protect your investment, have all major service and repair work done by your supplier.

⚠ WARNING

1. **Your chair needs regular maintenance for peak performance and to avoid injury from chair failure, damage or premature wear.**
2. **Inspect and maintain this chair strictly per the "Maintenance Chart" (p. 47)**
3. **If you detect a problem, make sure to service or repair the chair before use.**
4. **At least once a year, have a complete safety check and service of your chair performed by a supplier.**

B. CLEANING**1. Paint Finish:**

- Clean the paint finish with mild soapy water monthly.
- Protect the paint with a coat of non-abrasive auto wax every three months.

2. Motors:

- Clean around motor area weekly with a slightly damp (not wet) cloth.
- Wipe off or blow away any fluff, dust, or dirt on or around the motors.

NOTE– You do not need to grease or oil the chair.

3. Upholstery:

- Hand-wash only as needed. Machine washing may damage fabric.
- Drip-dry only. Heat from a dryer may damage fabric.

NOTE– Washing the fabric may decrease fire retardant properties.

C. STORAGE TIPS

1. Store your chair in a clean, dry area. If you fail to do so, parts may rust or corrode.
2. Before using your chair, make sure it is in proper working order. Inspect and service all items on the "Maintenance Chart" (See p. 47)
3. If you store this chair for more than three months, have it inspected by a supplier before use.

D. BATTERY MAINTENANCE**⚠ WARNING**

1. **To prevent an acid spill, always keep batteries upright.**
2. **Never smoke or hold an open flame near batteries.**
3. **Always wear rubber gloves and safety glasses when you handle batteries.**

1. Maintenance Schedule:

This varies for different types of batteries. Always follow the instructions supplied with your batteries.

NOTE– Always wear rubber gloves and safety glasses when you handle or service batteries.

2. Adding Water: (Wet Cells Only)

- Wet-type lead acid batteries need periodic replacement of water lost due to evaporation.

NOTE– Use distilled water only.

- Check the battery fluid level about once a week. When you remove the stoppers (on top of the battery) there should be one-eighth to one-quarter of an inch of fluid above the internal plates. Do not overfill.

3. Corrosion:

Check battery terminals often for corrosion.

- a. If corrosion is present, use a wire brush to clean the terminals.

NOTE– Always wear safety glasses and rubber gloves.

- b. Use baking soda to neutralize acid.
- c. Use petroleum jelly to re-grease the terminals after connecting cables to battery. (Completely cover the terminal nut and bolt, cable clip and any exposed cable with jelly).

4. For Answers To Questions: Contact your supplier.**E. PNEUMATIC TIRES****⚠ WARNING**

1. **Do not use this chair if any of the tires are under- or over-inflated.**
2. **Low pressure in a tire may cause the chair to veer to one side and result in loss of control.**
3. **An over-inflated tire may burst.**
4. **Never use a gas station pump to inflate a tire. Such pumps provide air at high volume and may cause the tire to burst.**

1. Check for signs of wear and correct air pressure in pneumatic tires weekly.
2. For best performance, inflate tires to the same pressure level, as shown on the tire sidewall:
 - 8" pneumatic casters - 30 to 40 psi
 - 12" pneumatic drive wheels - 35 to 45 psi

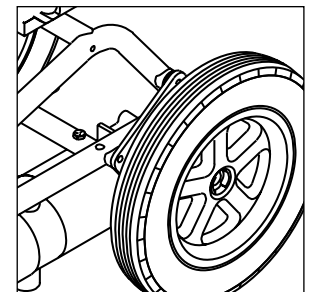

3. **CAUTION**– To prevent tire damage:
- Use a hand pump (or a **low volume** air pump) to inflate tires.
 - Use a tire gauge to check pressure.

F. TO REPAIR OR REPLACE A TIRE

⚠ WARNING

Residual air pressure in tires can cause severe injury. Make sure you release all air in tire before attempting to service or repair tires.

1. 8" Caster Wheels:

- a. Release all air from tire.
- b. Remove caster wheel from fork.
- c. Make sure there is no residual air in tire before you remove bolts that hold the two rim halves together.
- d. Remove four bolts from rim. Separate two halves of rim.
- e. Repair or replace inner tube.
- f. Reassemble the caster wheel; make sure the bearing spacer is in place and all four bolts are secure.

NOTE– Use a torque setting of 240 inch-pounds when tightening bolts.

- g. Mount caster wheel onto fork. Install washers correctly.
- h. Inflate tire to proper pressure level.

2. 12" Drive Wheels:

- a. Elevate and securely support chair so that wheel is off the ground. Release all air from tire.
- b. Remove plastic dome plug.
- c. Remove lock nut and tab washer.
- d. Remove wheel.
- e. Repair or replace inner tube.
- f. Install wheel on chair by replacing center tab washer and lock nut. **Use a torque setting of 420 in/lbs. to re-tighten nut.** Bend washer tabs up to secure nut and install plastic dome plug.
- g. Inflate tire to proper pressure level (listed on tire sidewall).

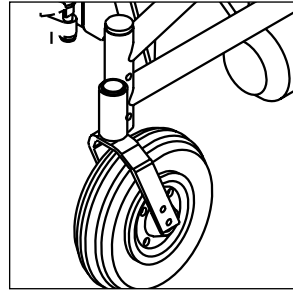

G. MOTOR BRUSHES

Check the motor brushes every four (4) months for wear. The brushes should be clean and shiny. Replace worn or blackened brushes.

H. ORDERING PARTS

When you order parts, provide the following:

1. Model of chair
2. Serial number of chair
3. Left hand or right hand control
4. Part number, description and quantity of parts you need.
5. State reason for replacement.

I. MAINTENANCE CHART

You should check the items on this chart at the indicated intervals. If any of the items are loose, worn, bent or distorted, immediately have them checked and/or repaired by your authorized Sunrise supplier. Frequent maintenance and servicing will improve performance, extend wheelchair life, and help prevent injuries.

CHECK...	Daily	Weekly	Monthly	Quarterly	Annually
Charge Batteries	✓				
Check tires for proper inflation level			✓		
Check batteries for proper electrolyte level (wet only)			✓		
Check plugs and connectors for proper connections				✓	
Check all moving parts for wear					✓
Inspect all nuts, bolts and fasteners for looseness or wear					✓
Inspect upholstery for wear					✓
Remove and inspect motor brushes					✓
Servicing by authorized Supplier					✓

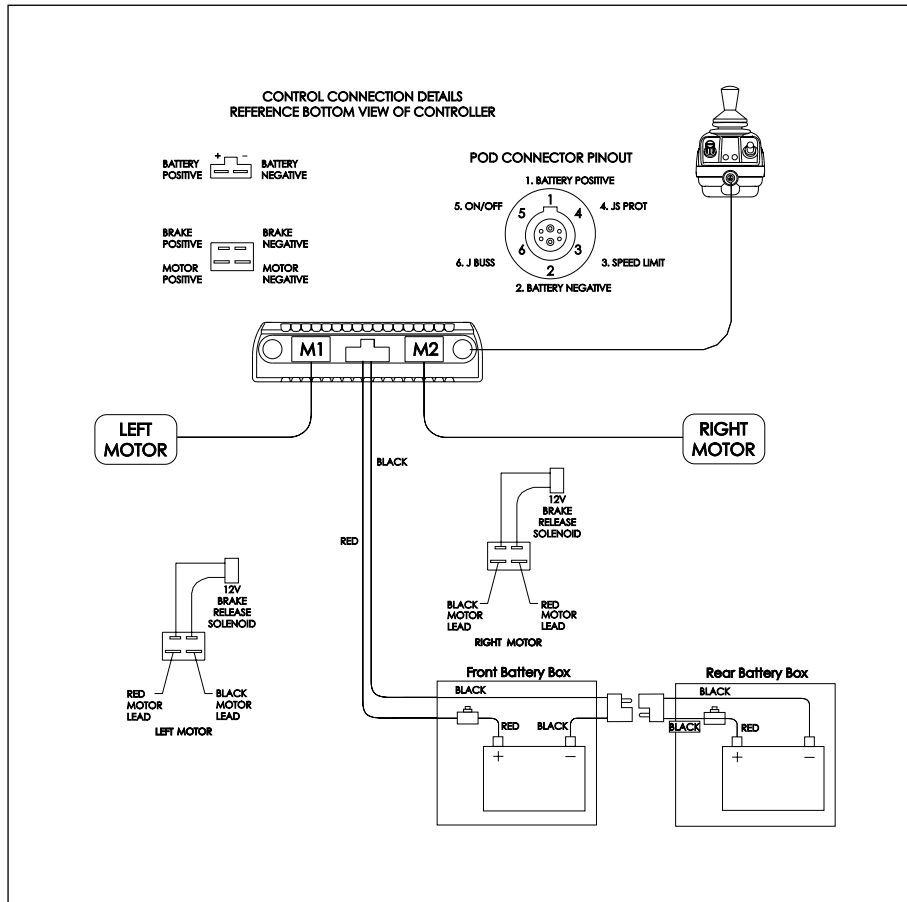

1. FOR LIFE

We warrant the main frame of this wheelchair against defects in materials and workmanship for the lifetime use of the first consumer purchaser.

2. ADDITIONAL WARRANTY

We warrant Sunrise-made components of this wheelchair against defects in materials and workmanship as follows:

- Main electronic controller—For two (2) years from the date of first consumer purchase.
- Motors, gear boxes and remote joystick—For one (1) year from the date of first consumer purchase.
- All other original components (such as wheels, upholstery, plastic, rubber parts and painted surfaces)—For three (3) months from the date of first consumer purchase.

3. LIMITATIONS

- We do not warrant damage due to:
 - Neglect, misuse, or improper installation or repair.
 - Use of parts or changes not authorized by Sunrise.
 - Exceeding the weight limit of 150 pounds.
- This warranty is **void** if the original chair serial number tag is removed or altered.
- This warranty applies in the USA **only**. Check with your supplier to find out if international warranties apply.

4. WHAT WE WILL DO

Our sole liability is to repair or replace covered parts. This is your only remedy for consequential damages.

5. WHAT YOU MUST DO

- Return the warranty card.
- Obtain from us, while this warranty is in effect, prior approval for return or repair of covered parts.
- Return the wheelchair or part(s), freight pre-paid, to Sunrise Mobility Products Division at: 2842 Business Park Ave., Fresno, CA 93727-1328.
- Pay the cost of labor to install or repair parts.

6. NOTICE TO CONSUMER

There are no other express warranties. To the extent permitted by law, any implied warranty (including a warranty of merchantability or fitness for a particular purpose) is limited to:

- One (1) year from the first consumer purchase, and
- Repair or replacement of the defective part **only**.

This warranty gives you certain legal rights. You may also have other rights that vary from state to state.



Sunrise Medical

7477 East Dry Creek Parkway • Longmont, Colorado • 80503 USA

(800) 333-4000

In Canada (800) 263-3390

© 2002, Sunrise Medical 12.02

930578 Rev A